

# ORBIS ULTRA SLIM

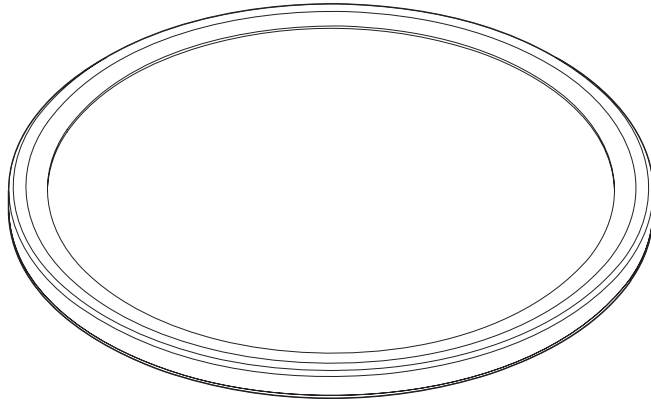

**NOT FOR PRINT  
PRODUCTION!**

**WARNING:**

This PDF file is for reference only and not to be used for the creation of production art. Colour printouts and screen displays should not be used for colour approval as colours may vary from device to device. The colour values for this file are defined in either Pantone (PMS), HKS, or in process colour (CMYK).

For obtaining hard-copies in actual size you need to enter the proper settings in your printer options.

**本品不可印刷生产**

**警告:**

本PDF文档仅作为参照文件，不能将本文件用于印刷生产或者制作菲林。  
本文件的彩色打印版本或其于电脑屏幕中显示的色彩，不可用于最终的色彩参照。因为打印机或设备的差异，可能造成色彩的偏差。最终式样的色彩请遵照由色板卡片PMS，HKS或者CMYK(青红黄黑)所定义的色彩。若本文件的打印件要获取1:1的原始尺寸在打印选项中作出相应的设置。



#5000000398900 #8X3 #ELA  
#ZNP 4171049 ORBIS ULTRA SLIM\_FA43111  
#0PP  
#2017-12-12 #  
#RL-Released  
ZGR 4178201-000-00

ORBIS ULTRA SLIM

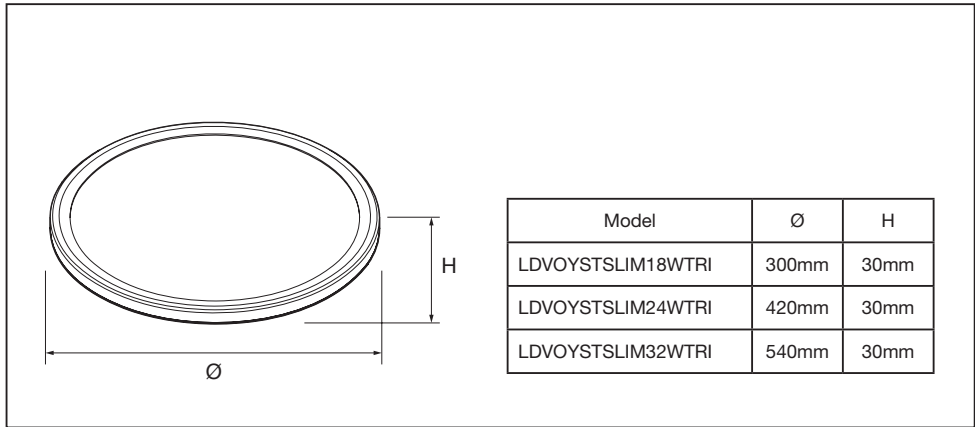

**1** Disconnect mains power before installation.

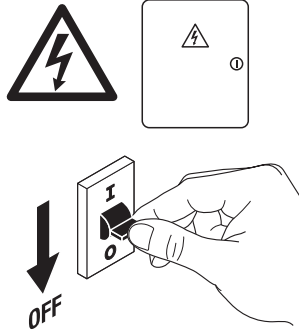

**2** Rotate the cover then lift it off.

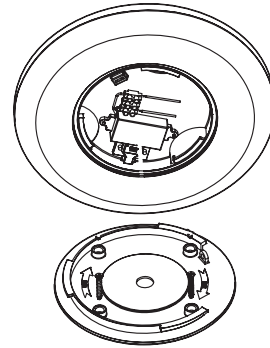

**3** Use the mounting holes provided on the plate.

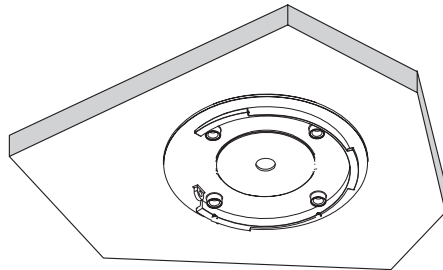

**4** Screw Installation plate into ceiling. Use appropriate ceiling anchors and ensure plate is well secured.

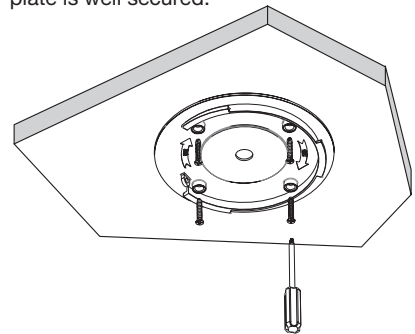

# ORBIS ULTRA SLIM

**5** Power Cable should be installed through the cable hole in the centre of the fixture. Protect cable with cable gland.

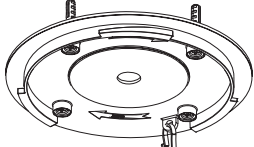

**6** Connect the fixture.

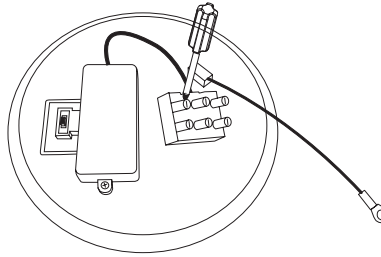

**7** Connect the Neutral, Earth and Live wires in the terminal block.

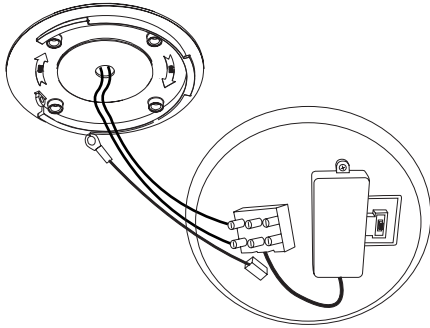

**8** Select desired colour temperature with side switch during installation: 3000K / 4000K / 6500K.

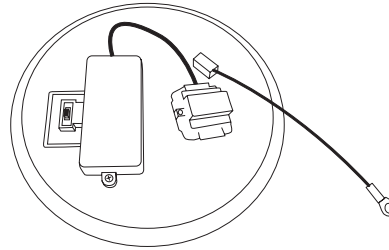

**9** Twist the fixture cover clockwise.

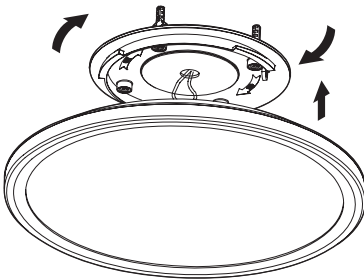

**10** Turn the power switch back on to verify that the product is working properly.

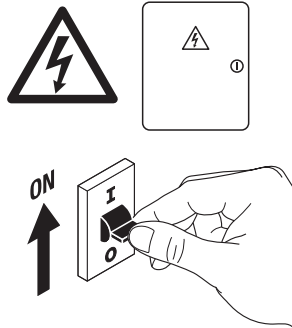

## WARNINGS:

- This product must be installed by a licensed electrician strictly in accordance with the current revision of AS/NZS3000 - Electrical Installations (Australian/New Zealand Wiring Rules).
- Avoid touching the LEDs.
- Please do not attempt to disassemble or change the construction of the luminaire or replace any of the parts to avoid the possibility of injury or product failure.
- Please keep this manual for future reference.
- Please note that the fixture is equipped with standard surge protection only. To protect the fixture from sags, surges, and lightning strikes, additional surge protectors must be deployed on the primary side.
- Fixture should not be removed from Installation plate, whilst the power is on.
- Power should not be on whilst fixture is not installed as this could lead to a electrical shock hazard.



## WARRANTY AGAINST DEFECTS:

Your ORBIS ULTRA SLIM fitting from LEDVANCE comes with a product warranty 5 years for quality assurance, the terms and conditions of which are set out in this document. The Warranty applies exclusively to LED Light Fittings from LEDVANCE purchased within Australia  
The Warranty is offered to you by:

LEDVANCE Pty Ltd  
Unit 3, 83 Derby Street  
Silverwater NSW 2128  
Phone 1300 467 726  
Email [technical.au@ledvance.com](mailto:technical.au@ledvance.com)

**IMPORTANT: Our goods come with guarantees that cannot be excluded under the Australian Consumer Law. You are entitled to a replacement or refund for a major failure and compensation for any other reasonably foreseeable loss or damage. You are also entitled to have the goods repaired or replaced if the goods fail to be of acceptable quality and the failure does not amount to a major failure.**

IP54

C10449057  
G11168672  
2023-05-04

LEDVANCE Pty Ltd  
ABN 34 050 103 181  
Unit 3, 83 Derby Street  
Silverwater, NSW, 2128, Australia  
Ph +61 29481 8399 / 1300 467 726  
[www.ledvance.com.au](http://www.ledvance.com.au)